

MAGLYTE-10 ANGULAR

Magnetic installation in the angular LED profile



- Groundbreaking magnetic installation
- Minimalistic, timeless design
- Lighting at a 45° angle
- Surface or suspended installation
- End caps with or without hole
- Angular connectors with suspending possibility



MAGLYTE-10 ANGULAR

material	aluminium
height	19,1 mm
width	14,8 mm
recommended LED strip width	10 mm
installation	surface magnetic in corners, suspended
type of lighting	furniture, zone, decorative
continuous line of light	from 192 P/m (details on the following pages)
lighting at an angle	45°
possible IP of LED luminaire	20

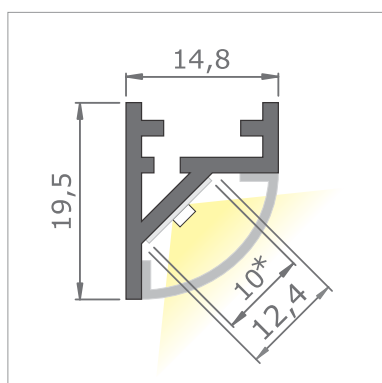

*recommended LED strip width

The angular lighting of MAGLYTE-10 ANGULAR is particularly well suited for illuminating kitchen countertops



AVA LIGHT Sp. z o.o.

Ul. Staszica 40T/4, 05-500 Piaseczno, Poland | NIP 123-15-75-215 | www.avalight.pl

Warehouse / Magazyn: ul. Puławska 38, 05-500 Piaseczno, Poland

MAGLYTE-10 ANGULAR

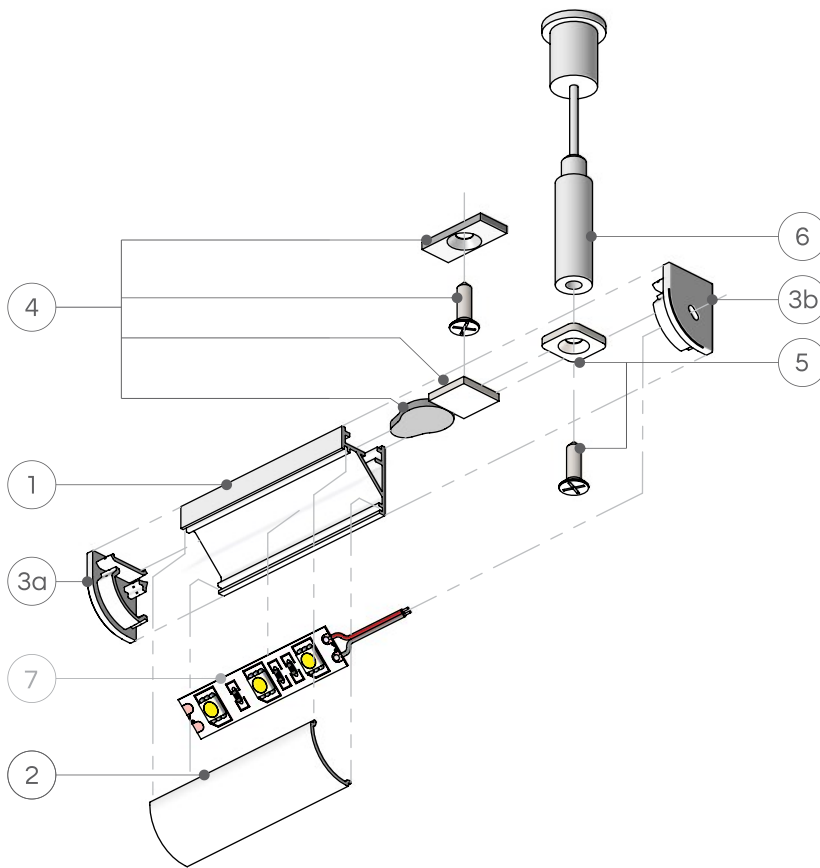

- 1 Profile LED MAGLYTE-10 ANGULAR
Profil LED MAGLYTE-10 ANGULAR
- 2 Diffuser LED D02
Dyfuzor LED D02
- 3a End cap MAGLYTE-10 ANGULAR without hole
Zaślepka MAGLYTE-10 ANGULAR bez otworu
- 3b End cap MAGLYTE-10 ANGULAR with hole
Zaślepka MAGLYTE-10 ANGULAR z otworem
- 4 Magnetic set
Zestaw magnetyczny
- 5 Holder for suspension AC01
Uchwył do zawiesia AC01
- 6 Steel cable suspension
Zawiesie z linką stalową
- 7 LED strip
Taśma LED

Available colours and lengths _____

Profile LED MAGLYTE-10 ANGULAR				
length / colour	raw aluminium	silver anode	black anode	white painted
2.030 mm	P03105_R2	P03106_A2	P03107_B2	P03108_W2
3.030 mm	P03105_R3	P03106_A3	P03107_B3	P03108_W3

















MAGLYTE-10 ANGULAR





Accessories

Continuous line of light in MAGLYTE-10 ANGULAR

Diffuser LED D02		
length / colour	opal	black
2.030 mm	D02204_O2	D02206_B2
3.030 mm	D02205_O3	D02207_B3
		

LED strip	Diffuser LED D01	
	opal	black
120 P/m (2210 lm/m)		
192 P/m (1799 lm/m)		
240 P/m (2800 lm/m)		
420 P/m (2301 lm/m)		
COB (950 lm/m)		
COB (1425 lm/m)		

-  continuous line of light, smooth effect
-  line through the center or barely visible points
-  visible points

Looking for a matching LED strip?
Contact us at info@avalight.pl

End caps MAGLYTE-10 ANGULAR (20 szt., L+R)			
type / colour	gray	black	white
without hole	E303D02G_L/R	E305D02_B_L/R	E304D02_W_L/R
with hole	E303D02_GH_L/R	E305D02_BH_L/R	E304D02_WH_L/R

Mountings	
Magnetic set	Holder for suspension AC01
AM_BOM_400_2	AC-404_2

Steel cable suspension		
silver	black	white
AS-403_2S	AS-403_2B	AS-403_2W

Connectors AC01			
90 deg (2 pcs)	120 deg (1 pc)	180 deg (2 pcs)	90 deg double-plane (1 pc)
AC_402_90_2	AC_406_120_1	AC_401_180_2	AC_407_90_1

Similar in the offer

MAGLYTE-10

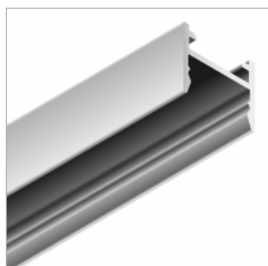

AVA LIGHT Sp. z o.o.
Ul. Staszica 40T/4, 05-500 Piaseczno, Poland | NIP 123-15-75-215 | www.avalight.pl
Warehouse / Magazyn: ul. Puławska 38, 05-500 Piaseczno, Poland



We shape the light

Ubieramy światło



AVA LIGHT Sp. z o.o.
Ul. Staszica 40T/4
05-500 Piaseczno
Poland
NIP 123-15-75-215

Warehouse / Magazyn:
ul. Puławska 38
05-500 Piaseczno
Poland



www.avalight.pl