

MAGLYTE-10

Magnetic installation in the basic surface profile

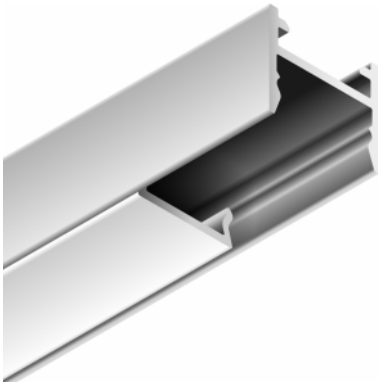

- Groundbreaking magnetic installation
- Minimalistic, timeless design
- Surface or suspended installation
- End caps with or without hole
- Angular connectors with suspending possibility



MAGLYTE-10

material	aluminium
height	12,5 mm
width	14,8 mm
recommended LED strip width	10 mm
installation	surface magnetic, suspended
type of lighting	furniture, zone, decorative
continuous line of light	from 240 P/m (details on the following pages)
lighting at an angle	-
possible IP of LED luminaire	20

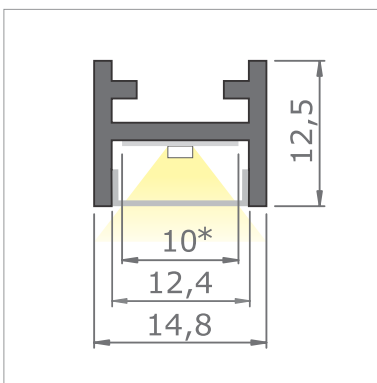

*recommended LED strip width

MAGLYTE-10 LED profile works well both as a suspended luminaire and as discreet accent lighting for niches or furniture elements.



MAGLYTE-10

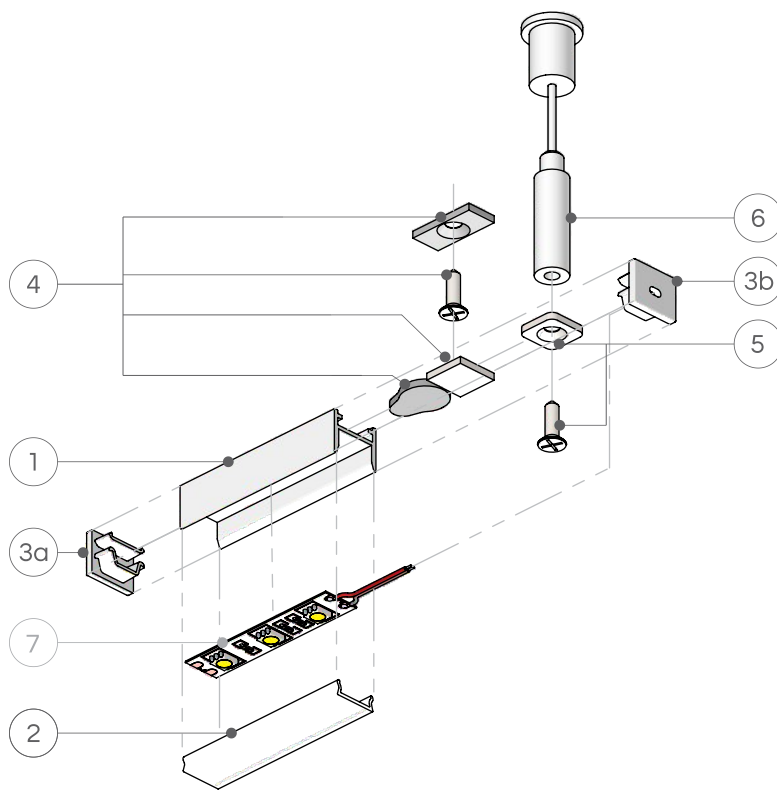

- 1 Profile LED MAGLYTE-10
Profil LED MAGLYTE-10
- 2 Diffuser LED D01
Dyfuzor LED D01
- 3a End cap MAGLYTE-10 without hole
Zasłepka MAGLYTE-10 bez otworu
- 3b End cap MAGLYTE-10 with hole
Zasłepka MAGLYTE-10 z otworem
- 4 Magnetic set
Zestaw magnetyczny
- 5 Holder for suspension AC01
Uchwyt do zawiesia AC01
- 6 Steel cable suspension
Zawiesie z linką stalową
- 7 LED strip
Taśma LED

Available colours and lengths _____

Profile LED MAGLYTE-10				
length / colour	raw aluminium	silver anode	black anode	white painted
2.030 mm	P00101_R2	P00102_A2	P00103_B2	P00104_W2
3.030 mm	P00101_R3	P00102_A3	P00103_B3	P00104_W3

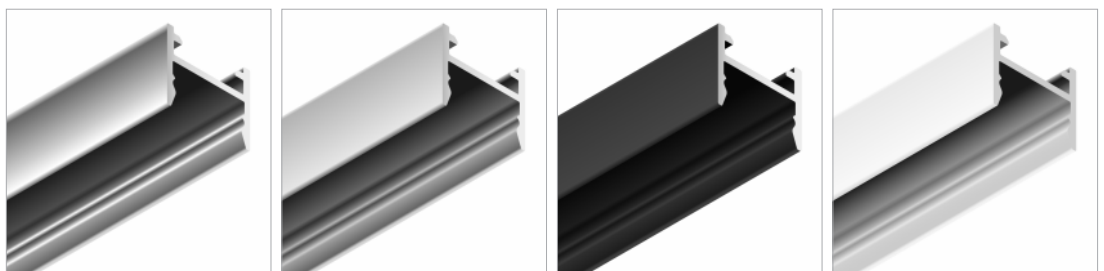



MAGLYTE-10

















Accessories

Continuous line of light in MAGLYTE-10

Diffuser LED D01		
length / colour	opal	black
2.030 mm	D01200_O2	D01200_B2
3.030 mm	D01201_O3	D01201_B3
9,09 m roll	D01202_OR9	D01202_BR9
15,15 m roll	D01203_OR15	D01203_BR15

LED strip	Diffuser LED D01	
	opal	black
120 P/m (2210 lm/m)		
192 P/m (1799 lm/m)		
240 P/m (2800 lm/m)		
420 P/m (2301 lm/m)		
COB (950 lm/m)		
COB (1425 lm/m)		

-  continuous line of light, smooth effect
-  line through the center or barely visible points
-  visible points

Looking for a matching LED strip?
Contact us at info@avalight.pl

End caps MAGLYTE-10 (20 pcs.)			
type / colour	gray	black	white
without hole	E300D01_G	E302D01_B	E301D01_W
with hole	E300D01_GH	E302D01_BH	E301D01_WH

Mountings	
Magnetic set	Holder for suspension AC01
AM_BOM_400_2	AC-404_2

Steel cable suspension		
silver	black	white
AS-403_2S	AS-403_2B	AS-403_2W

Connectors AC01			
90 deg (2 pcs)	120 deg (1 pc)	180 deg (2 pcs)	90 deg double-plane (1 pc)
AC_402_90_2	AC_406_120_1	AC_401_180_2	AC_407_90_1

Similar in the offer

MAGLYTE-10 ANGULAR

BASELYTE-10 LOW

BASELYTE-10 HIGH

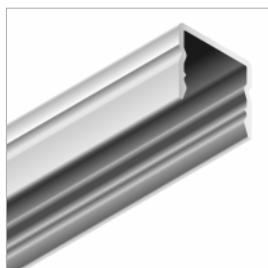
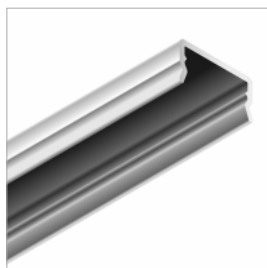

AVA LIGHT Sp. z o.o.

Ul. Staszica 40T/4, 05-500 Piaseczno, Poland | NIP 123-15-75-215 | www.avalight.pl

Warehouse / Magazyn: ul. Puławska 38, 05-500 Piaseczno, Poland



We shape the light

Ubieramy światło



AVA LIGHT Sp. z o.o.

Ul. Staszica 40T/4
05-500 Piaseczno
Poland
NIP 123-15-75-215

Warehouse / Magazyn:

ul. Puławska 38
05-500 Piaseczno
Poland



www.avalight.pl